

**RANGE**

**ULM**

Ultra Light Manitou

1.25 and 1.5 tons



Discover your  
machinery in 3D

 **MANITOU**  
HANDLING YOUR WORLD





## Our commitment!

Manitou is committed to reducing the total cost of ownership of your machine (TCO).

### ● Quick and easy maintenance

Service intervals and error codes are displayed on the dashboard display.

A large opening engine bonnet on the side of the machine allows easy access to the main components.

The fuel and hydraulic oil tanks are easily accessible and clearly identified.

A hatch at the front of the radiators allow straw and dust to be removed easily.

The battery is easily accessible, just under the cab.

### ● -25% hydraulic oil

The hydraulic oil tank is fitted with an anti-aeration filter which reduces the volume of hydraulic oil required by 25%.

### Reduce your fuel consumption

The Stop & Start option reduces fuel consumption, CO<sub>2</sub> emissions, the number of recorded engine hours and noise pollution by automatically stopping the engine when the machine is stationary. Engine restart is automated without turning the key.

## Secure operators and their environment

Manitou is committed to designing machines that ensure optimum safety for users.

### ● Easy access cab

Easily access the cab through a large opening door without a step.

### ● Automatic parking brake

Each time the machine stops, the parking brake is automatically engaged for greater safety.

### ● Joystick with driver presence sensor

Equipped with a sensor, the joystick automatically detects your hand. It only authorizes the movements requested by the operator.

### ● Accessory tilt lock

A button in the cab is used to lock the tilting function, so you can work calmly.

### ● Battery cut-off

This system manually cuts the power in the electrical circuit of the machine.

### ● Orange belt

Visible belt for added safety of the operator (standard or optional depending on the type of seat).

### Safety pack

An optional device which accompanies and protects the operator whilst informing them in real time of a potential risky manoeuvre. It simultaneously warns people in the vicinity via an external warning light and sends the information to the fleet manager. A simple tool to acquire the right reflexes and promote safe operating behaviour!



## Treat yourself to a pleasant workspace...

Find many advantages offered by the Manitou brand with the ULM...

### ● Driving assistance

A set of pop-ups informs the operator in real time about the use of the machine.



### ● Joystick on floating armrest

Exclusive to Manitou, the JSM allows you to control all movements in complete safety and without fatigue, with just one hand. You always keep one hand on the steering wheel for total control of your machine.



### ● Optimal visibility

The roof window is made of polycarbonate, a transparent and very resistant material that meets the FOPS standards (protection against falling objects). The hoses are well protected inside the boom for clear visibility on the right side.

## At your service!

Focus on your core business and leave the rest to us.

### ● The myMANITOU app

Stay connected to your Manitou via an application to view your machine remotely, anticipate maintenance and analyze its performance. Share the data with your nearest dealer to benefit from personalized advice and enhanced responsiveness in the event of a breakdown.

### ● Financing contract

Manitou offers financing solutions to help you realize your projects. Talk to your dealer and we will find the most suitable solution!

### ● Extended warranty

Operate with complete peace of mind for up to 6 years or 6,000 hours thanks to a modular extended warranty.

### ● Maintenance contract

With a maintenance contract, you have the assurance of reliable and irrefragable service. Your maintenance budget is predictable, clear and without surprises. In case of transfer, your machine will be even more valued.

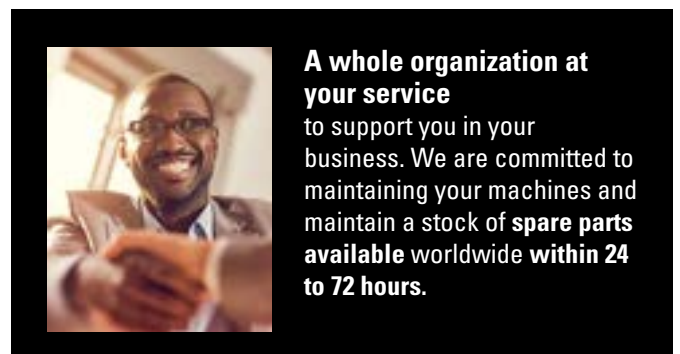

### A whole organization at your service

to support you in your business. We are committed to maintaining your machines and maintain a stock of **spare parts available** worldwide **within 24 to 72 hours.**



Max lifting height

**4.3 m**

2 models to choose from

**1.25 t or 1.5 t**



**3** steering modes

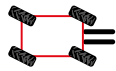
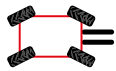
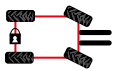

**35.1 hp (26.2 kW) engine**  
It meets the Stage V environmental standard.  
Exhaust gas treatment is carried out using a DOC (Diesel Oxidation Catalyst) and a particulate filter.

#### Simultaneous boom movements

The flow sharing distributor enhances simultaneous hydraulic movements for efficient work. You choose to do one or several movements at the same time for more precision.

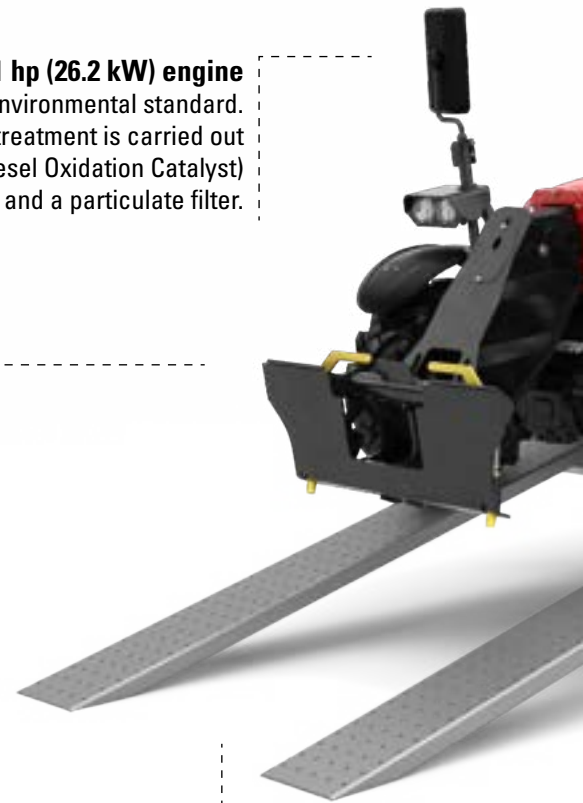

## Reduced transportation costs

### Lightweight

Machine transportable on a trailer with a GVWR\* of 3.5 tons

GVWR (Gross Vehicle Weight Rating)

Compact Dimensions (LxWxh).

**3.47 x 1.49 x 1.92 m**

### Travel Safety

Well-identified tie-down points and accessible to front and rear of the machine

### Folding Forks

Optional fork transport retainers (with floating carriage) reduce overall transport length and increase road travel safety.

### Inching function

This feature speeds up movement of the boom while limiting the forward speed of the machine. It is particularly useful for bale stacking or pallet handling.

**29 cm**  
Ground clearance



### An all-terrain machine

Its ground clearance of 29 cm allows it to easily overcome all obstacles. The oscillating rear axle guarantees a maximum grip and stability. The machine is equipped with 4-wheel drive and fenders at the front of the machine, standard.

## ULM telehandler

The Ultra Light Manitou was designed to save you time and money. It is suitable for many environments, whether for landscaping sites, equestrian centers, renovation sites, etc.

Its ultra-compact dimensions and its ground clearance of 29 cm makes it an ideal choice for moving around in tight spaces and off-road. Thanks to its light weight, the machine can easily be transported on a small trailer (PTAC 3500 kg).

## Such a light and compact machine that it can be transported on a trailer



### Electronic carriage compensation system

By replacing the hydraulic compensation with an electronic compensation, we improve visibility at the rear of the machine (by removing the cylinder). This also reduces its weight, thus optimizing fuel consumption.

### Limited slip differential on the front and rear axles

Even on muddy terrain, the machine overcomes all obstacles.

### Hydrostatic transmission

With a simple gesture, choose your speed (+/- buttons on the JSM). The hydrostatic transmission guarantees handling without jolts, perfect in cramped spaces. Changing gears can be done while driving, saving you time!

### Compactness and maneuverability

With a width of 1.49 m and a height of 1.92 m, the machine moves with ease in the tightest spaces (urban or congested construction sites, garage entrances, stalls, etc.). The small turning radius and 4-wheel steering mode make maneuvering even easier.





## A multifunction machine at your service in daily life

Thanks to the large choice of accessories designed and validated by the Manitou group, your ULM machine can easily be transformed into a tool carrier allowing you to place or stack loads, clear snow, sweep your site, cut a branch or load bulk materials.

### Light material bucket

Designed for bulk material with a density maximum of 800 kg/m<sup>3</sup>, this bucket allows high productivity when loading thanks to its capacity of 770 litres.



### General purpose buckets

Dedicated to construction applications for moving bulk material with a maximum density of 2100 kg/m<sup>3</sup> and a 400 liter capacity.



### Grapple bucket

Multifunctional and efficient, it allows you to load and unload bulk material with a maximum density of 1000 kg/m<sup>3</sup> and maximum capacity of 600 liters.



### Snow blade

Easy to use and solid, it is designed to withstand all winters by effectively clearing snow in a single pass.



### Wrapped Bale Clamp

Qualitative and easy to use, this clamp is made for transporting and storing wrapped bales. The smooth arm structure avoids any perforation of the film.



### Manure fork

Robust and versatile solution for cleaning and moving bulky manure or bales of hay. The 90° opening of the grapple makes it possible to work flush with the walls.



### 3 attachment carriages available

Skid Steer carriage (SK)  
Euro carriage (EU)  
4 point carriage



Find accessories on  
[manitou.com](http://manitou.com)



|   |         | <b>ULM 412 H</b> | <b>ULM 415 H</b> |
|---|---------|------------------|------------------|
| <b>Maximum Capacity</b>                       | kg      | 1250             | 1500             |
| <b>Maximum Lifting Height</b>                 | m       | 4.30             | 4.30             |
| <b>Maximum Forward Reach</b>                  | m       | 2.62             | 2.62             |
| <b>Shipping Mass (Min/Max)</b>                | kg      | 2550 / 2750      | 2700 / 2900      |
| <b>Dimensions without attachments (LxWxh)</b> | m       | 3.47x1.49x1.92   | 3.47x1.49x1.92   |
| <b>Outer Turning Radius</b>                   | m       | 2.62             | 2.62             |
| <b>Engine Manufacturer</b>                    |         | Yanmar           | Yanmar           |
| <b>Engine Standard</b>                        |         | Stage V          | Stage V          |
| <b>Engine Power</b>                           | hp (kW) | 35.1 (26.2)      | 35.1 (26.2)      |
| <b>Transmission Type</b>                      |         | Hydrostatic      | Hydrostatic      |
| <b>Maximum Travel Speed</b>                   | km/h    | 25               | 25               |
| <b>Hydraulic Flow</b>                         | l/min   | 48               | 48               |

**ULM 412 H**

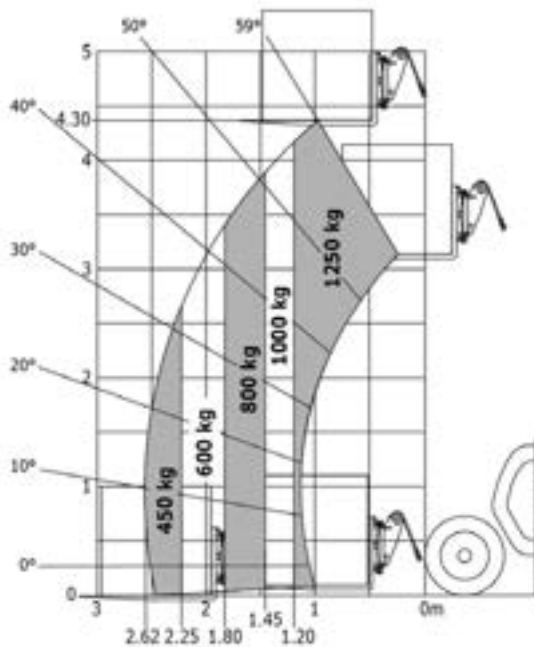

Rough terrain load chart (EN1459 B)  
500 mm load center

**ULM 415 H**

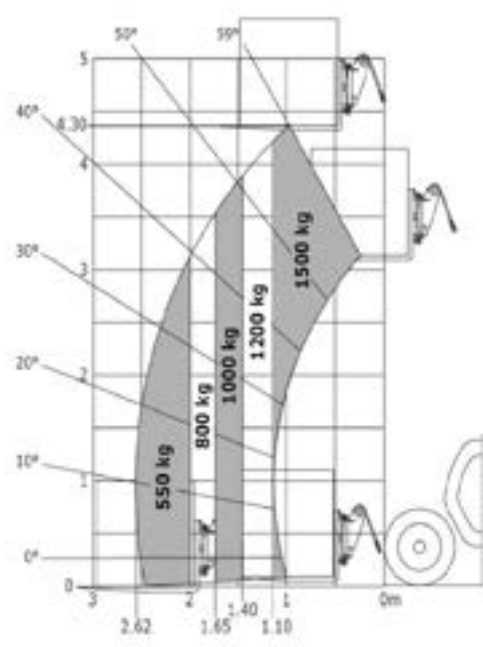

Rough terrain load chart (EN1459 B)  
500 mm load center

## A tailor-made solution adapted to your needs

Discover a wide range of options. To have access to all the options, ask your Manitou contact for advice.



### Air Conditioning

Air conditioning with manual regulation to improve cab comfort.



### Car Radio

Directly within reach in the armrest.

## 3 levels of finishes

**Essential:** basic finish with mechanical vinyl seat.

**Comfort:** mechanical vinyl seat, accessory hydraulic line, Easy Connect System, wiper on roof window, sun visor, adjustable steering column, floor mat, full road lighting, flat LED rotating beacon, LED work lights on cab (x4).

**Classic:** mechanical fabric seat, accessory hydraulic line, Easy Connect System, wiper on roof window, sun visor, adjustable steering column, floor mat, full road lighting, flat LED rotating beacon, LED work lights on cab (x4), material baffle on boom head, air pre-filter, auto reversing fan, rear mudguards, rear electric plug, tuner car radio, telephone holder, interior mirror.



As a business or operating manager, we measure the TCO of our equipment precisely. We are looking for versatile, robust and easy-to-maintain machines that meet the constraints of our business.

**Contact your dealer**



Scan and discover more information on **manitou.com**

 **MANITOU**  
**HANDLING YOUR WORLD**