

McHale

VARIABLE CHAMBER BALER RANGE



WWW.MCHALE.NET

The Professional Choice

MCHALE VARIABLE CHAMBER BALER RANGE

Over the last decade the McHale range of balers have been operating in over 6 continents in some of the world's most difficult conditions. McHale balers have developed a reputation for providing **HIGH OUTPUT, EXCELLENT RELIABILITY, OPERATOR COMFORT AND TOP RESALE VALUE.**

CONTENTS

Introduction	1 - 4
VARIABLE CHAMBER BALER RANGE	5 - 8
Inner Workings	9 - 10
Pick-Up	11 - 12
Rotor/Split Drive Gearbox	13 - 14
Chopper Unit	15 - 16
Drop Floor	17 - 18
Bale Chamber	19 - 21
Oiling & Greasing	22
High Performance Netter	23 - 24
Expert Plus Control Console	25 - 26
V6740 - Non-Chopper Baler	27 - 28
V6750 - Chopper Baler	29 - 30
V8940 - High-Capacity Non-Chopper Baler	31 - 32
V8950 - High-Capacity Chopper Baler	33 - 34
Optional Extras	35 - 36
INTEGRATED BALER WRAPPER	37 - 42
Standard Specifications	38
Patents/Wrapping System	39 - 40
iTouch Control Console	41 - 42
TECHNICAL TABLE	44



Latest machine in the range:
**McHale V8 Variable
Chamber Baler**



A FAMILY BUSINESS WITH A GLOBAL PRESENCE



*McHale was founded by Padraic and Martin McHale in the mid 1980s in the west of Ireland and since then has transformed into a **GLOBAL LEADER IN THE MANUFACTURE OF GRASSLAND EQUIPMENT.***

In 1976, Padraic established a farm machinery retail outlet and was later joined in this endeavour by his younger brother Martin. The manufacturing company subsequently evolved from this dealership which is still in existence today.

From the start, Padraic looked after product design and manufacturing while Martin looked after sales and marketing. Although the business has grown substantially since, both brothers are still actively involved in the business and still manage these areas.

Following on from producing blockcutters and a range of slurry pumping equipment, in 1987, McHale manufactured its first round bale wrapper. Martin then developed a dealer and importer network which has expanded to 55 countries around the world.

Over 90% of McHale machines produced are destined for the export market and many of these dealers and importers have been working with McHale for over 30 years.

McHale now produce a wide range of products with a particular focus on grassland machinery. The McHale product range now incorporates:

- **Mowers**
- **Tedders**
- **Rakes**
- **Integrated Baler Wrappers**
- **Fixed Chamber Balers**
- **Variable Chamber Balers**
- **Round Bale Wrappers**
- **Square Bale Wrappers**
- **Straw Blowers & Silage Feeders**
- **Bale Handling and Splitting Equipment**



Padraic and Martin McHale
in 1990 (above) & 2019 (below)



Global Manufacturing



Today McHale operate two advanced manufacturing facilities. **Both factories utilise the latest in laser, CNC and robotic technologies.** All products are coated using advanced E-Coat & Powder systems.

As the product is built on the assembly lines, rigorous quality checks are conducted. Every complete machine is run, calibrated and tested before being exported to one of over 55 countries around the world.



Research & Development



The Research & Development department was established in 1994 and is still run by Padraic who has built a world class team of engineers around him.

All machines go through a **rigorous 3-year product development & testing cycle** before being launched. During the design and development stage all machines go through comprehensive testing with end users in various parts of the world.

Today, **over 10% of the workforce** are involved in new product development.

Product Support



Our specially **trained team of service engineers** are on hand to help in a quick and precise manner in order to provide the solutions you and your business need.

We also empower the service engineers of our dealers and importers with theoretical and practical training to ensure you receive **high-quality expertise and care** for you, your machine and your business. Qualified and equipped with the necessary knowledge and tools, our aim is to keep your business going at all times.

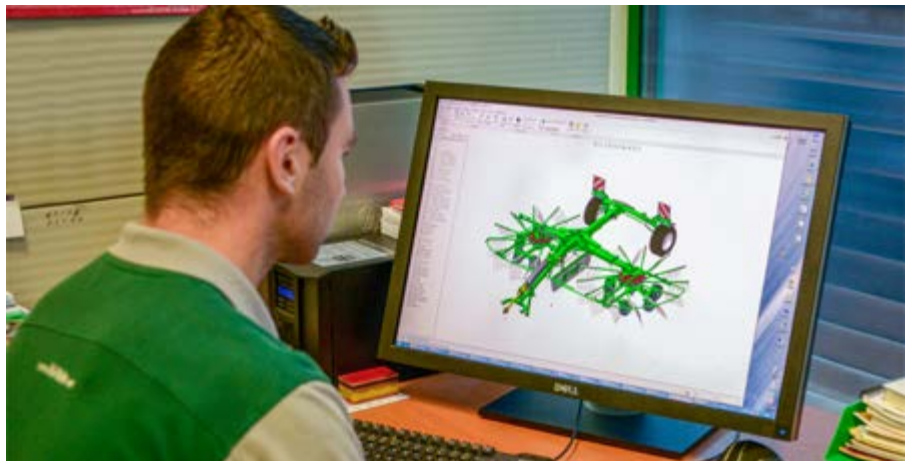

Spare Parts



With all parts in stock for McHale machines, our aim is to **supply original parts and components** that are specifically suited to your machine.

McHale stock a wide range of parts for machines produced up to 30 years ago as well as parts for the latest products in the range. These **parts are precisely manufactured** in order to meet the highest standards of performance and reliability.

FIVE MODELS A RANGE TO MEET YOUR NEEDS

The McHale variable chamber baler range is made up of **V6, V8 AND FUSION VARIO** machines. The range consists of **5 MODELS**;

All V6 and Fusion Vario machines make bales from **0.6–1.68m (2'–5'6")**. For farmers and contractors seeking to produce a larger diameter bale, the McHale V8 is capable of making a bale from **0.6–1.9m (2'–6'3")**. The five models in the range are;

- 1. V6740** – Non-Chopper Baler
- 2. V6750** – Chopper Baler
- 3. V8940** – High-Capacity Non-Chopper Baler
- 4. V8950** – High-Capacity Chopper Baler
- 5. Fusion Vario** – Integrated Baler Wrapper

Offering innovative ideas to allow you to work smarter, whilst achieving more output, the McHale name has become synonymous with the production of robust and reliable machines, making McHale the number one choice for professional users.

McHale make a high output baler to suit everyone's needs. Whether it is a non-chopper V6740/V8940 baler, a 15 knife chopper V6750/V8950 baler or a Fusion Vario integrated baler wrapper, there is a host of options to choose from to suit your individual needs.

Unfold this page for a summary of the models in the variable chamber baler range.



1

V6
740

THE MCHALE V6740 is a non-chopper variable chamber baler capable of producing bales from 0.6–1.68m (2'–5'6"). It is equipped with a high intake, twin finger feed rotor to ensure even and efficient crop flow to the bale chamber.

The McHale V6740 is driven by a primary drive system for optimum bale formation. Central grease blocks are fitted on the machine for greasing whilst oiling is controlled through the continuous oiling system which is driven from the gearbox. Net and bale density can be adjusted through the Expert Plus control console. The machine is fitted with 460/65-20 tyres as standard.

01 2.1m PICK-UP
High-Intake Pick-Up
with Galvanised Bands

02 FEED ROTOR
High Intake Feed Rotor

03 CHOPPER UNIT
Non-Chopper

04 DRIVE SYSTEM
Primary Drive

05 CONTROL SYSTEM
Expert Plus

06 GREASING
Centralised
Greasing Blocks

V6 BALE SIZES

Unwrapped
All forage types

0.6m
(2')

1.68m
(5'6")



Pictured:
V6740

2

V6
750

THE MCHALE V6750 is a semi-automatic variable chamber baler capable of producing bales from 0.6–1.68m (2'–5'6"). The machine is fitted with a 15-knife chopper unit and heavy-duty rotor. A double drive system aids belt rotation and bale formation to allow the machine to

operate in the toughest of conditions. The machine comes with centralised grease blocks as standard. Automatic greasing is available as an optional extra. Net and bale density can be adjusted from the cab through the Expert Plus control console. The machine is fitted with 500/50-22.5 tyres as standard.

01 2.1m PICK-UP
High-Intake Pick-Up
with Galvanised Bands

02 FEED ROTOR
15 Knife
Heavy-Duty Rotor

03 CHOPPER UNIT
15 Knife
Chopper Unit

04 DRIVE SYSTEM
Double Drive

05 CONTROL SYSTEM
Expert Plus

06 GREASING
Centralised
Greasing Blocks

Higher specification over the V6740

3

V8
940

THE MCHALE V8940 is a high-capacity, non-chopper variable chamber baler capable of producing bales from 0.6–1.9m (2'–6'3"). It is equipped with a high intake, twin finger feed rotor to ensure even and efficient crop flow to the bale chamber. The V8940 is driven by a primary drive

system for optimum bale formation. Central grease blocks are fitted on the machine for greasing whilst oiling is controlled through the continuous oiling system which is driven from the gearbox. Net and bale density can be adjusted from the cab through the Expert Plus control console. The machine is fitted with 460/65-20 tyres as standard.

01 **2.1m PICK-UP**
High-Intake Pick-Up
with Galvanised Bands

02 **FEED ROTOR**
High Intake Feed Rotor

03 **CHOPPER UNIT**
Non-Chopper

04 **DRIVE SYSTEM**
Primary Drive

05 **CONTROL SYSTEM**
Expert Plus

06 **GREASING**
Centralised
Greasing Blocks

V8 BALE SIZES
Unwrapped
All forage types

0.6m
(2')

1.9m
(6'3")



Pictured:
V8950

4

V8
950

THE MCHALE V8950 baler is a high-capacity, semi-automatic variable chamber baler which is fitted with a 15-knife chopper unit and heavy-duty rotor. It is capable of producing bales from 0.6–1.9m (2'–6'3"). A double drive system aids belt rotation and bale formation to allow

the machine to operate in the toughest of conditions. The machine comes with centralised grease blocks as standard. Automatic greasing is available as an optional extra. Net and bale density can be adjusted through the Expert Plus control console. The machine is fitted with 500/50-22.5 tyres as standard.

01 **2.1m PICK-UP**
High-Intake Pick-Up
with Galvanised Bands

02 **FEED ROTOR**
15 Knife
Heavy-Duty Rotor

03 **CHOPPER UNIT**
15 Knife
Chopper Unit

04 **DRIVE SYSTEM**
Double Drive

05 **CONTROL SYSTEM**
Expert Plus

06 **GREASING**
Centralised
Greasing Blocks

Higher specification over the V8940

INTEGRATED BALER WRAPPER

THE MCHALE FUSION VARIO is an integrated baler wrapper, which provides a number of benefits as the task of baling and wrapping can be carried out using one machine. There is also a labour saving, as one operator, one tractor and one machine can complete baling and wrapping duties. It features two unique patents; a patented bale transfer system and a patented vertical wrapping ring. Controlled by an iTouch control console, the operator has the ability to make various size bales across different types of crops.

VARIO BALE SIZES

Wrapped
Haylage/Silage

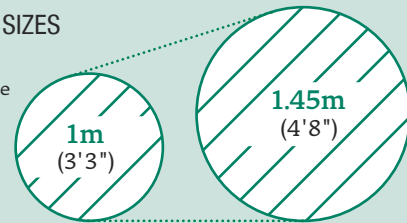

VARIO BALE SIZES

Unwrapped
All forage types

0.6m
(2')

1.68m
(5'6")



Pictured:
Fusion Vario

Integrated Vertical Wrapping Ring

The integrated wrapping ring features;

- A High Speed Wrapping System
- Film Break Sensors
- Patented Bale Alignment
- Two 750mm Dispensers

01 2.1m PICK-UP
High-Intake Pick-Up
with Galvanised Bands

02 FEED ROTOR
15 Knife
Heavy-Duty Rotor

03 CHOPPER UNIT
15 Knife
Chopper Unit

04 DRIVE SYSTEM
Double Drive

05 CONTROL SYSTEM
iTouch

06 GREASING
Automatic
Greasing System

THE INNER WORKINGS

DRIVE SIDE

The **MACHINE GUARDING** on the variable chamber baler range has been designed using a durable twin skin composite. Once the guarding of the machine is opened up, it gives the **OPERATOR EASY ACCESS TO THE MACHINE COMPONENTS.**

01 Continuous Oiling System

Once the PTO is engaged, all chains receive oil continuously to ensure the highest standards of reliability.

04

High Performance Stretch Net System

A simple netting system allows for the net tension on the bale to be progressively increased using an hydraulic brake. This variable stretch system ensures even net application during the entire bale binding process.

02

Two Roll Net Loading & Storage

The operator simply releases the straps on the spare roll of net on the machine platform and moves the roll of net into position. Storage for two extra rolls of net is provided on the baler platform.

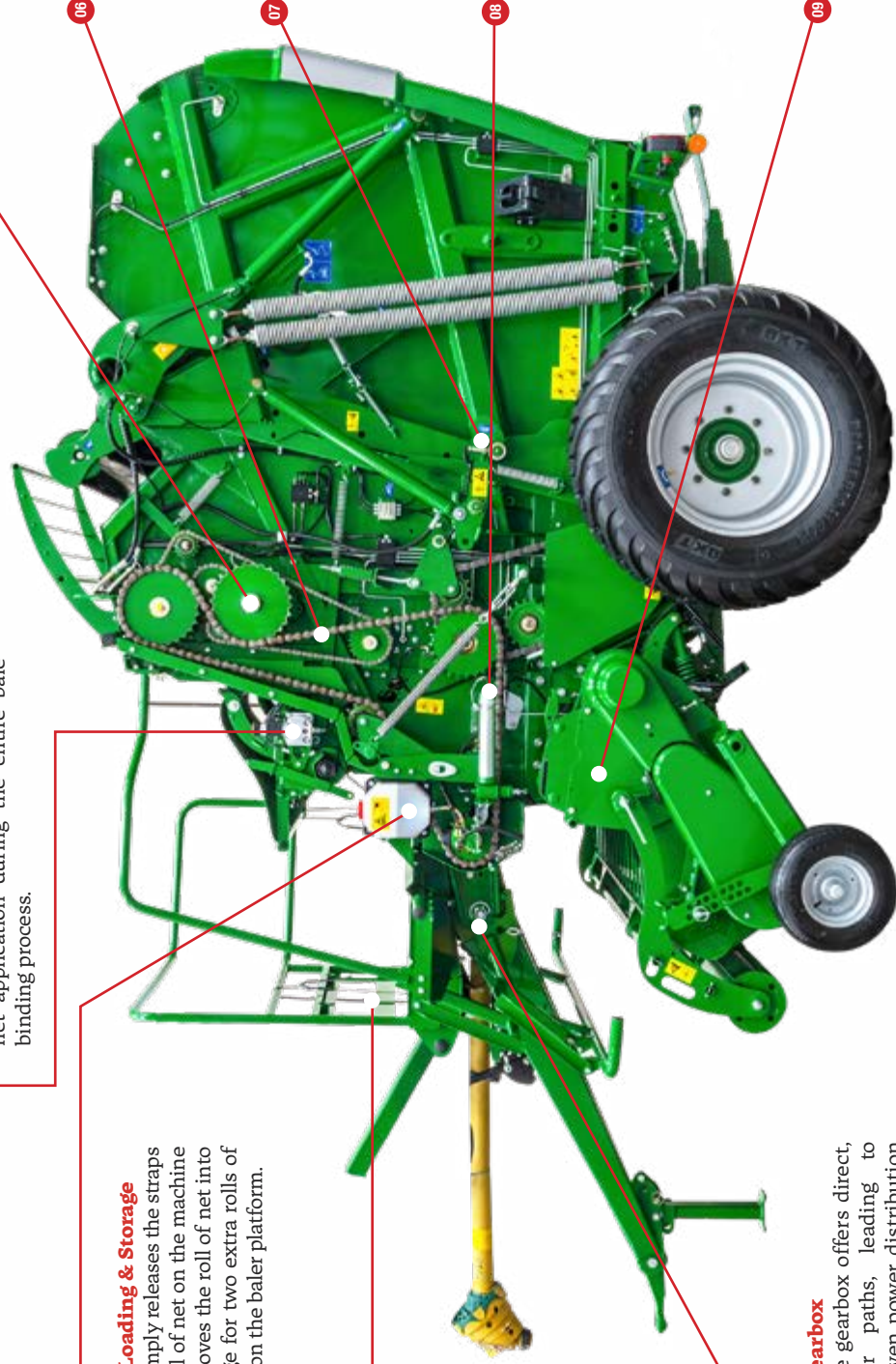

05

Bale Chamber Double Drive

On the McHale V6750, V8950 & Fusion Vario, the double drive aids belt & material rotation in more difficult conditions.

06

Heavy-Duty Chains

Heavy-duty 1 1/4 drive chains ensure long life with minimum service intervals.

07

Mechanical Tailgate Locking

The bale chamber is kept securely closed with mechanical tailgate locks that open only to release the bale. Resulting in maximum baling density.

08

Greasing

All drive and non-drive side chamber bearings and rotor bearings are being greased as the machine is working through the greasing cycle. As standard on all V6 and V8 machines, there are a number of centralised greasing blocks. On the Fusion Vario, automatic greasing comes as standard.

Automatic greasing is an available option on the V6750 & V8950.

09

15 Knife Chopper Unit

The 15 knife chopper unit is the standard chopper unit in the McHale V6750, V8950 and Fusion Vario machines. A bank of 15 knives provide a chop length of approximately 65mm.

THE INNER WORKINGS

NON-DRIVE SIDE

10

Cleaning Augers

A cleaning auger is fitted to the double drive which prevents crop build up. When the machine works in wet and sugary crops, the cleaning auger keeps the double drive clean.

14

Bale Shape Indicators

The bale shape indicators ensure that when the machine works in a light swath, the best bale shape is achieved by alerting the driver via the control console, which side of the chamber needs to be filled.

15

Central Greasing for Ram Ends & Door Hinges

A central greasing block allows the operator to easily supply grease to the door rams and hinges.

11

Heavy-Duty Springs

4 heavy-duty springs pressurise the crop at the start of the baling process. The tension placed on the belt(s) by these large springs allows for the perfect start to the bale as the operator can start at full speed. The spring tension on the belts ensures easy bale formation and a well formed core.

12

Simple Belt Tracking Adjustment

Belts can be simply adjusted at the rear of the machine to ensure for optimum bale formation.

13

Heavy-Duty 8 Stud Axle

The heavy-duty axle design gives greater ground clearance and the 8 stud axle configuration ensures the axle stands up to the most testing ground conditions.

An optional Hydraulic or Air braked axle is available.

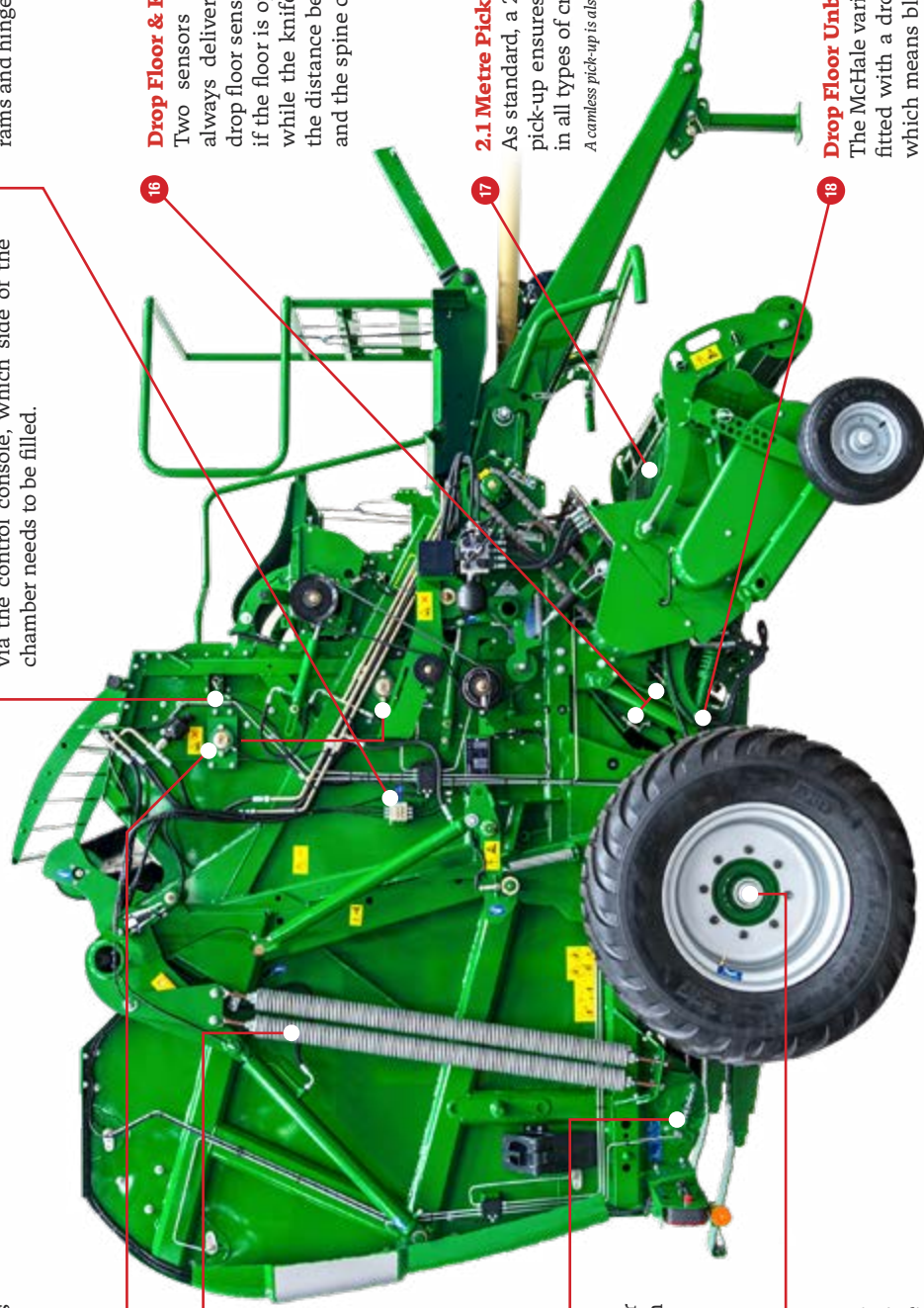

16

Drop Floor & Knife Position Sensors

Two sensors ensure that the machine always delivers a good chop quality. A drop floor sensor indicates to the operator if the floor is open via the control console while the knife position sensor monitors the distance between the top of the knife and the spine on the rotor.

17

2.1 Metre Pick-Up

As standard, a 2.1m high intake galvanised pick-up ensures excellent ground cleaning in all types of crop.

A camless pick-up is also available as an option.

18

Drop Floor Unblocking

The McHale variable chamber baler range is fitted with a drop floor unblocking system, which means blockages can be fed through in three simple steps.

PICK-UP

Over the last decade, McHale have developed various types of pick-ups. After extensive testing, McHale decided it would offer customers the **CHOICE OF 2 PICK-UP OPTIONS;**

1 Cam Pick-Up

As standard, a cam operated **2.1m high-intake galvanised** pick-up ensures excellent ground cleaning in all types of crop. The cam pick-up runs on a cam track that is fitted with **double raced cam bearings** to stand up to the most testing of conditions. All pick-ups across the McHale variable chamber baler range are fitted with 5 tine bars for excellent delivery of crop to the bale chamber. The 2.1 metre galvanised pick-up will lift even the shortest of crop.

A **side inspection port** allows the operator to quickly check and change the cam bearings at recommended service intervals.

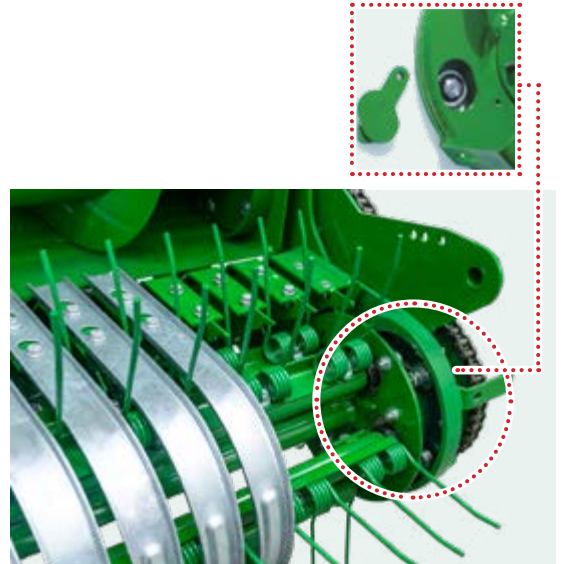

2 Camless Pick-Up

A 2.1m camless pick-up is available as an option on all machines in the variable chamber baler range. Six tine bars are fitted to all McHale camless pick-ups to provide excellent ground cleaning and fast delivery of crop to the chamber. The new camless pick-up has been designed for increased output, with that in mind the cam-track free pick-up is more reliable, consists of less moving parts and is maintenance free.



For more information please see the range of options available on [page 35](#).



All McHale pick-ups come with a number of **STANDARD FEATURES THAT INCLUDE:**

01 Heavy-Duty Pick-Up

All McHale pick-ups feature heavy-duty tine bar supports to ensure a long service life. A vital part of the pick-up is the tine, McHale have developed a pick-up tine designed to lift even the shortest of crop.

02 Efficient Crop Flow Delivery

The specially designed McHale pick-up is positioned close to the rotor to improve delivery of the crop through the rotor to the bale chamber. Large diameter lateral feed augers help direct crop to the bale chamber ensuring a consistent and even crop flow for producing high density bales.

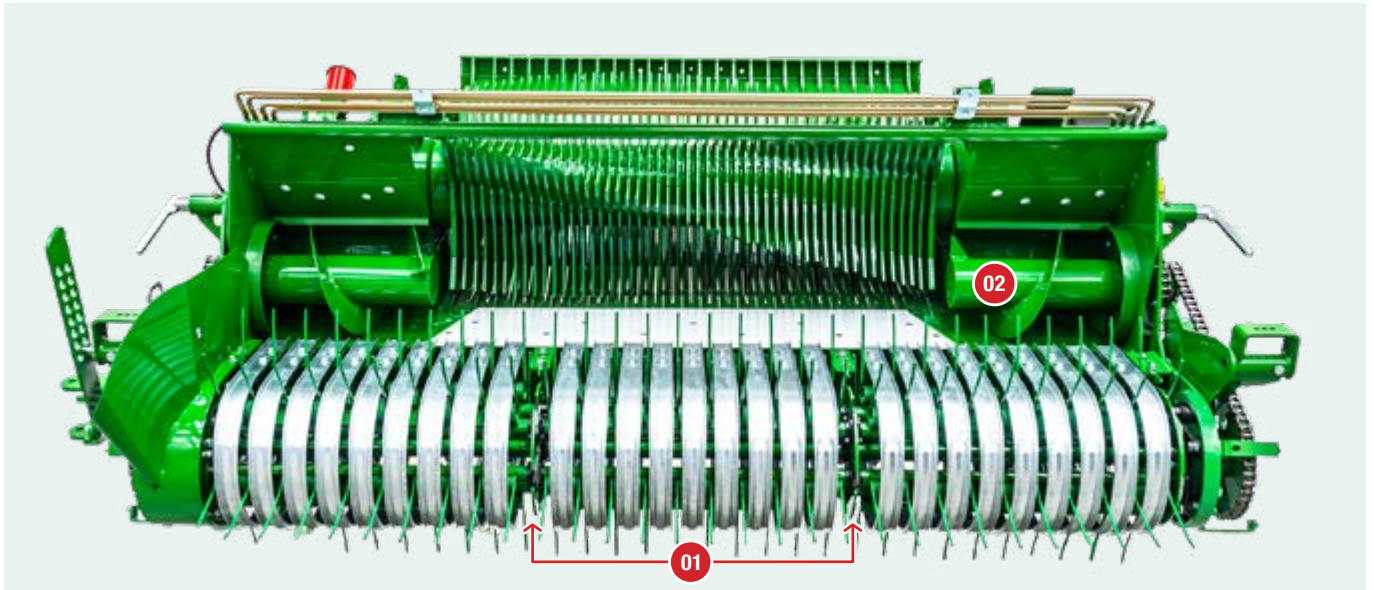

03 Adaptive Intake

Over the course of a baling season, machines have to work with different volumes of crop. McHale have designed an adaptive intake which allows the intake area to automatically adjust for light and heavy crops. This avoids peak loads and results in higher daily throughput regardless of working conditions.

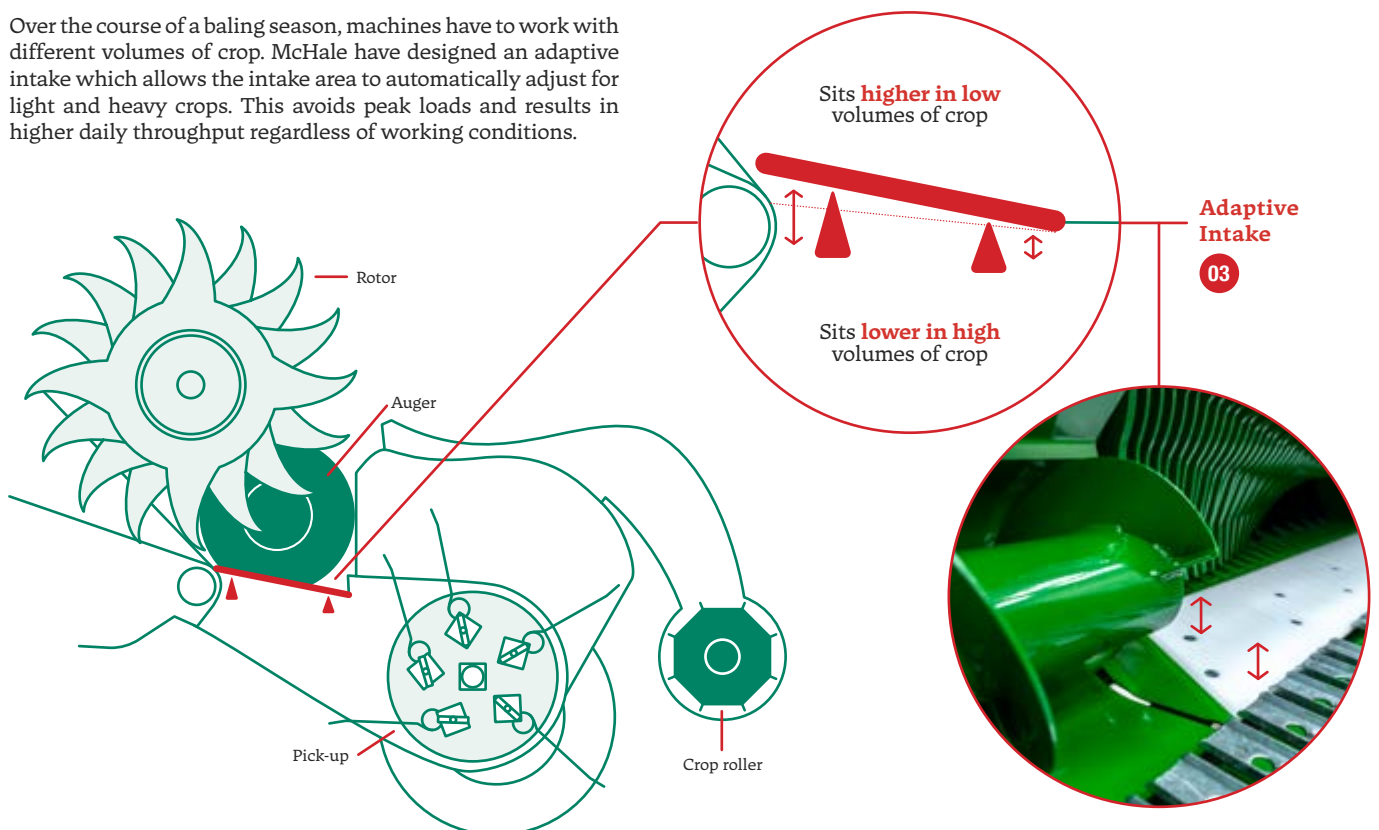

SPLIT DRIVE GEARBOX

A SPLIT DRIVE GEARBOX is fitted to all machines in the McHale variable chamber baler range.

All machines in the McHale variable chamber baler range come fitted with a 540rpm gearbox as standard. The gearbox design ensures that power is evenly distributed to both sides of the machine. The belt(s) in the bale chamber are driven from the left-hand side of the machine, and the pick-up and chopper unit are driven from the right-hand side of the machine. This system ensures direct, short transfer paths, leading to optimal power distribution.

McHale machines work in different conditions around the world. In order to optimise machine performance, a 1000rpm gearbox is available as an optional upgrade on all machines in the McHale integrated baler wrapper range.

We recommend you speak with your local dealer or distributor regarding which gearbox is better suited to your requirements based on your working conditions.

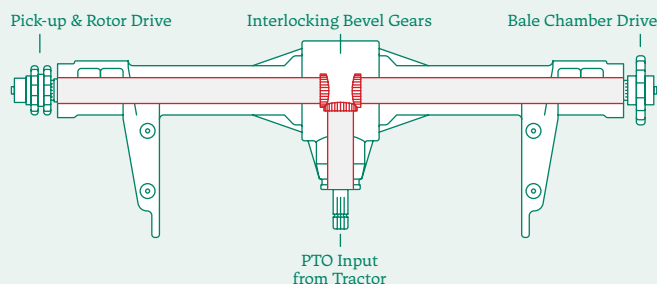

ROTOR

The star shaped feed rotors ensure a HIGH-CAPACITY FLOW of grass into the bale chamber.

The flights on the rotors are laid out in a spiral formation to achieve consistent crop flow. As crop enters the rotor, rotating flights feed the crop to the bale chamber. The flights on the rotor ensure high output, while the star layout reduces the load peaks as the machines work in heavy swaths. **McHale have designed three rotors for the variable chamber baler range:**

1 Non-Chopper Twin Finger Rotor

Standard on:
V6740 & V8940



2 15 Knife Chopper Rotor

Standard on:
V6750, V8950 & Fusion Vario



3 25 Knife Chopper Rotor

Optional on:
V6750, V8950 & Fusion Vario





BENEFITS OF CHOPPING CROP

Across the world, the benefits of baled crop can be seen. By also chopping the crop, it delivers the following benefits;

BETTER QUALITY

The quality of the crop is enhanced by chopping as chopped crop is easier to compress to form heavy, dense bales that are much tighter due to the air being expelled from the bale. This also leads to a reduction in transport and net costs.

BETTER FERMENTATION

Chopping allows for the crop to ferment better as the sugars in the crop will be readily available from the dry grass. This will result in the production of superior quality fodder that will be easily digestible for your animals.

EASIER FEED OUT

Chopped forage is easier to distribute from diet feeders and straw blowers. Short material can be processed and distributed from diet feeders and straw blowers much faster than longer material.



The chopping unit boasts a **heavy-duty rotor and comb**. The flights are **welded on both sides** for superior strength and on the drive side the rotor is fitted with a **double row bearing** with a long service life.



Rotor Type	Machine	Rotor Formation	Flight Thickness	Number of Knives	Selectable Knives
Non Chopper	Standard: V6740 & V8940	Spiral	Inner: 8mm Outer: 12mm	0	Not Available
15 Knife Chopper	Standard: V6750, V8950 & Fusion Vario	Spiral	Inner: 8mm Outer: 12mm	15	V6750 & V8950: Optional Fusion Vario: Not Available
25 Knife Chopper	Optional: V6750, V8950 & Fusion Vario	Spiral	Inner: 6mm Outer: 12mm	25	Optional

VARIABLE CHAMBER BALER CHOPPER UNITS

To ensure a consistent and even chop quality, **TWO CHOPPING OPTIONS** have been developed for the McHale variable chamber machines.

1 15 Knife Chopper Unit

The 15 knife chopper unit is the standard chopper unit on the **McHale V6750, V8950 and Fusion Vario machines**. A bank of 15 knives provides a chop length of **approximately 65mm**.



2 25 Knife Chopper Unit

The 25 knife chopper unit is available as an option on the **McHale V6750, V8950 and Fusion Vario** variable chamber machines. A bank of 25 knives provides a chop length of **approximately 46mm**.

For more information please see the range of options available on **page 35**.

Selectable Knife System

All McHale V6750, V8950 and Fusion Vario machines have the option to be fitted with a **selectable knife system**. Various knife configurations can be chosen depending on the knife bank specification as **shown in these charts with red and blue lines indicating individual knives**;

15 Knife Bank Options - 0, 7, 8, 15

No Banks: 0 knives

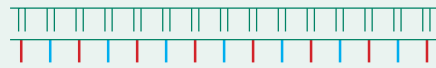

Bank 1: 7 knives

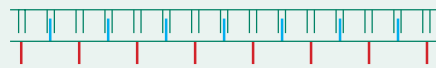

Bank 2: 8 knives

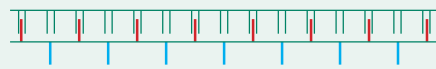

Bank 1 & 2: 15 knives

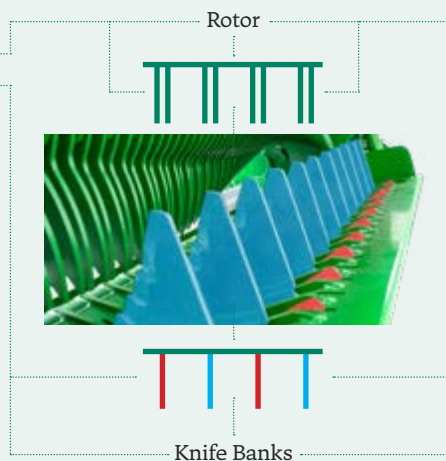

25 Knife Bank Options - 0, 12, 13, 25

No Banks: 0 knives



Bank 1: 12 knives

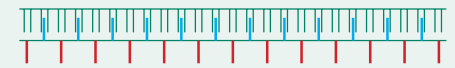

Bank 2: 13 knives

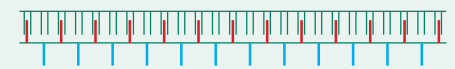

Bank 1 & 2: 25 knives

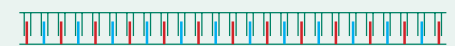

For more information please see the range of options available on **page 35**.

Knives

The knives in the chopping unit are made from hardened tool steel, which ensures long life and maximum productivity, by reducing the maintenance associated with knife sharpening.

Chop Quality

The knives in the chopping unit can be hydraulically engaged from the tractor cab. When engaged, the knives extend into the spine of the rotor, which ensures a consistent chop quality. A primary hydraulic knife protection system protects the knife bank(s) should it encounter a foreign object. A secondary protection system is in place on each individual knife.

Consistent Results

To ensure that the machine always delivers a good chop quality, two monitoring systems have been put in place on the V6750, V8950 and Fusion Vario. Firstly, knife working pressure is monitored and displayed on the control box. Secondly, a sensor monitors the distance between the top of the knife and the spine of the rotor to ensure the knives are fully engaged.

BENEFITS OF SELECTABLE KNIVES

ADJUSTABLE CHOP LENGTH

With selectable knives, the operator can vary their chop length by engaging or disengaging either knife bank. If fine chopping is required, the operator can choose to engage both knife banks. A reduction in chop length can also be quickly and easily achieved without the operator having to remove knives.

CONSISTENTLY SHARP KNIVES

When the operator is using only one knife bank, this can easily be swapped to the second knife bank from the cab to provide a fresh set of sharp knives. By having consistently sharp knives, fuel consumption is reduced as less power is required to chop the crop with sharp knives.

OPERATOR COMFORT

Without the operator having to physically replace knives, a new sharp set of knives can be engaged, ensuring a well chopped crop and continued high output. Should different chop lengths be required the operator can make the adjustments without having to alter the knives.



DROP FLOOR UNBLOCKING THREE SIMPLE STEPS

For over a decade, all machines in the variable chamber baler range are fitted with the McHale **DROP FLOOR UNBLOCKING SYSTEM**, a feature which operators have come to love for its simplicity of use and effective unblocking cycle.

As baling conditions are not always ideal, uneven swaths can occur which can lead to blockages. The McHale variable chamber baler range is fitted with a drop floor unblocking system, which means blockages can be fed through in **three simple steps**.

1 Drop the Floor

Should a blockage occur, the sound of the slip clutch alerts the operator, who can hydraulically lower the floor from the tractor cab.

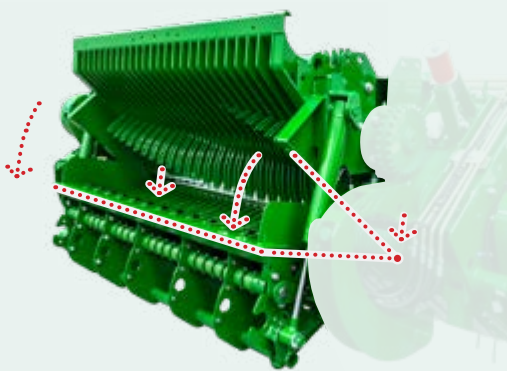

2 Re-engage the PTO

This widens the feed channel at both the **front and rear of the drop floor** where the blockage is more likely to occur. **By lowering the front and rear of the drop floor, the blockage can be fed through and effectively cleared when the PTO is re-engaged.**



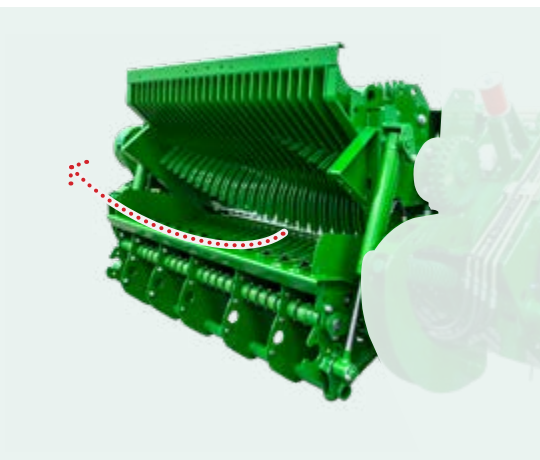

3 *Reset the Floor*

The floor can then be reset to its original position and baling can resume.



UP TO
1.9m
(6'3")

Features of the Drop Floor

When operating the drop floor cycle on the variable chamber baler range, the knives and the drop floor drop together during the unblocking process, giving even more clearance to allow the blockage to be fed through.

On the variable chamber machines, the drop floor is equipped with a drop floor sensor to ensure the chop quality is consistent by indicating to the operator via the control console if the drop floor is open and the knives are down.



Drop Floor Sensor

BALE CHAMBER & BALE SIZES

The bale chamber on the McHale variable chamber baler range is comprised of **HEAVY-DUTY ENDLESS BELT(S)**. The belts are extremely hard wearing and are reinforced

with synthetic material, which ensures that the belt(s) can **ABSORB AND APPLY HIGH PRESSURE** to the material in the bale chamber.



V6740 & V6750

The **V6740 & V6750** balers can make a bale from **0.6–1.68m (2'–5'6")**.

V8940 & V8950

The **V8940 & V8950** balers can make a bale from **0.6–1.9m (2'–6'3")**.

Unwrapped

All forage types

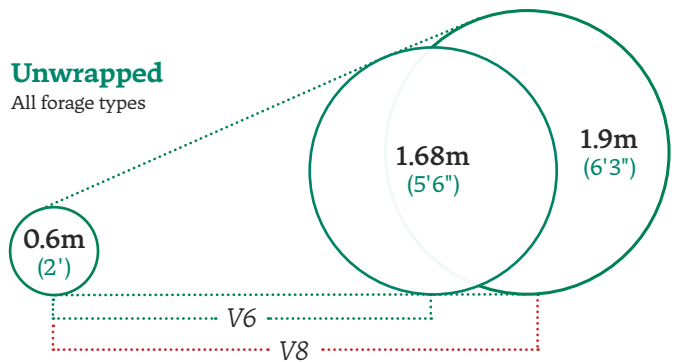

Size increments

The bale size on **all five machines** can be adjusted up from the minimum setting in **increments of 10mm (2/5")**.

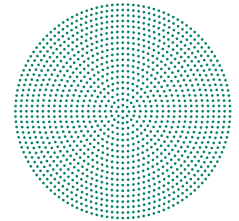

BALE CHAMBER BALE FORMATION

01 McHale have developed a bale chamber that can quickly form the bale from the start. The operator can commence baling at full speed as the **progressive density system** can quickly adjust to ensure that pressure is exerted on the crop right from the core of the bale, regardless of bale size.

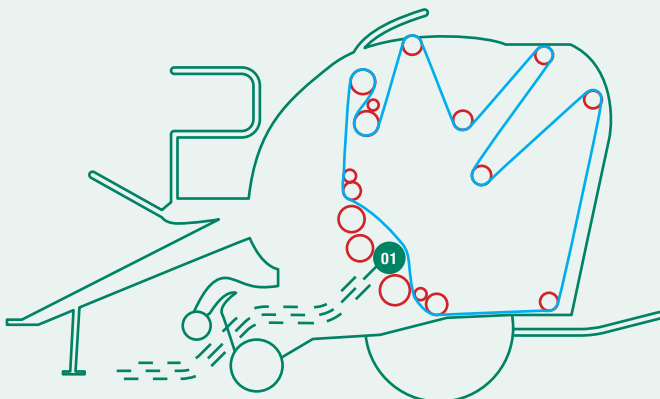

02 This is done by **four heavy-duty springs** that pressurise the crop at the start of the baling process. The tension placed on the crop by these large springs allows for the perfect start to the bale. The spring tension on the belt(s) ensures easy bale formation and a properly formed core.

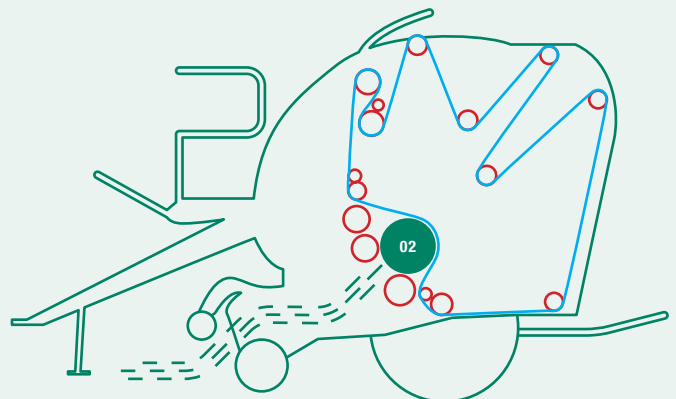

Fusion Vario

The **McHale Fusion Vario** also has the ability to make bales of **hay and straw** from **0.6–1.68m (2'–5'6")** but in **haylage or silage**, produces bales from **1–1.45m (3'3"–4'8")** to allow for wrapping.

Unwrapped

All forage types

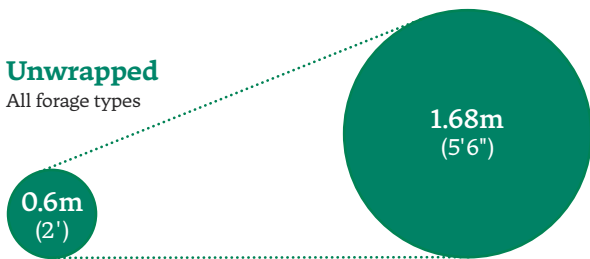

Wrapped

Haylage/Silage

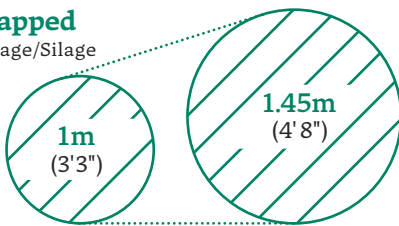

03 As the bale is forming inside the chamber, the hydraulics take over the tensioning of the belt(s) from the four large springs. Two hydraulic rams control the tension on the chamber belt(s) as the bale forms inside the chamber.

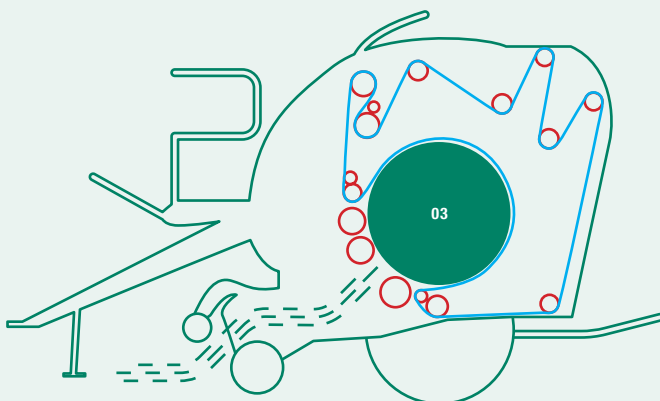

04 Just like the core of the bale, the outer layers are compressed at the same consistent pressure using both springs and hydraulics until the set bale density and size is reached.

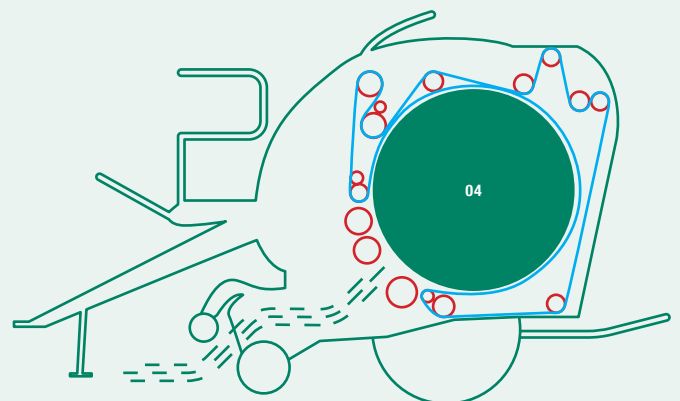

BALE CHAMBER DOUBLE DRIVE

A heavy-duty drive system powers belt and bale rotation on all machines in the variable chamber baler range. A primary drive system powers the belt(s) on all McHale V6740 and V8940 machines. On all McHale V6750, V8950 and Fusion Vario machines, a **DOUBLE DRIVE SYSTEM** is fitted to ensure belt rotation and bale formation.

Double Drive

In more difficult conditions, such as wet heavy grass, if the primary drive slips slightly, the double drive will engage in order to aid belt and material rotation in the chamber. This double drive helps bale formation as a constant pressure is kept on the chamber belt(s) which results in the production of a solid and uniform

bale even when dealing with a wet and heavy crop.

A cleaning auger is fitted to the double drive system in order to prevent crop build up and allow the double drive to aid bale rotation when working in wet or sugary crops.



Double Drive

Bale Shape Indicators

Ultra-sonic bale shape indicators are fitted to all McHale V6 and Fusion Vario machines and indicate to the operator via the control console which side of the chamber needs to be filled. All machines in the McHale V8 variable chamber baler range are fitted with load sensing bale shape indicators that directly measure the bale pressure inside the chamber.

By comparing the loading on each side of the chamber, the bale shape is calculated and then indicated to the operator via the control console, which side of the chamber needs to be filled. This direct measuring of the chamber pressure allows the bale shape indicators to be extremely accurate and responsive.



V6 & V8 Bale Shape Indicators

Mechanical Tailgate Locking System

The tailgates on all McHale variable chamber balers are fitted with a pair of mechanical locks, which keep the bale chamber securely closed. These locks remain activated until, the progressive density system reaches

the preset bale size and density and the required amount of net has been applied. This eliminates the need for the chamber door to rely on hydraulic pressure when making high density bales.



Mechanical Tailgate Locks

BALE CHAMBER - BELT OPTIONS

Three Endless Belts

All **V6 & V8 variable chamber balers** are equipped with **3 heavy-duty endless belts** as standard. These strong belts exert a high pressure on the bale in order to form a dense bale in the chamber. These belts are manufactured to the highest of standards using layers of synthetic and rubber material to form a durable endless belt with no joins.

Single Belt

All McHale **Fusion Vario** machines are equipped with a **single, full-width endless belt** as standard. This full width belt **reduces crop loss**, particularly in alfalfa or chopped material and provides better belt traction for the operator compared to multiple endless belts.

A single full width endless belt is also available as an **optional extra** on the **V6740 & V6750** variable chamber balers.

For more information please see the range of options available on [page 35](#).

OILING & GREASING

Continuous Oiling System

The McHale variable chamber baler range of balers are all fitted with a continuous oiling system. Once the PTO is engaged, the continuous oiling system constantly lubricates the chains to ensure a long lifetime. A lube alarm sounds after 300 bales to inform the operator to refill the oil tank. The continuous oiling system on the machine is driven off the gearbox and delivers oil to **the following chains**:

1 Chamber Drive Side Chains

2 Rotor Drive Chain

3 Pick-Up Drive Chains

4 Pick-Up Cam Track

5 Pick-Up Drive Gears

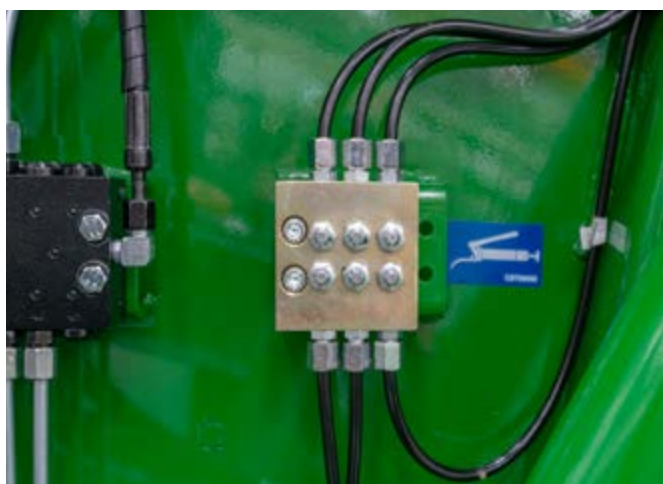

Greasing

All machines come fitted with a number of manual greasing points which are easily accessible throughout the baler either individually or through a centralised greasing block.

The following bearings highlighted below are greased:

Automatic Greasing

Automatic greasing is standard on all McHale Fusion Vario machines but is available as an option on all McHale V6750 & V8950 machines. A pressurised system delivers a measured amount of grease around the baler every time a bale is ejected from the bale chamber. Automatic greasing saves time as it reduces the amount of manual greasing to be done by the operator. The grease cartridge should be refilled after 1200 bales.

For more information please see the range of options available on page 35.

1 Bale Chamber Drive Side

2 Bale Chamber Non-Drive Side

3 Rotor Bearings Drive Side

4 Rotor Bearings Non-Drive Side

Machine	V6740 & V8940	V6750 & V8950	Fusion Vario
Centralised Greasing Blocks	Standard	Standard	Standard
Automatic Greasing	Not Available	Optional	Standard

HIGH PERFORMANCE NETTER

A high performance netter has been **DESIGNED AND DEVELOPED** for the McHale variable chamber baler range. This netter is very reliable and features:



Endless Adjustment

Endless adjustment of tension to ensure **optimum net usage** and bale shape



Up to 1300mm

Capacity to take rolls of net wrap up to **1300mm** in width and **4500m** in length



180-Degree Wrap

180-degree wrap around on the rubber feed roller, **eliminating any net slippage** while feeding





Net Stretch Application

A simple netting system allows for the net tension on the bale to be progressively increased using the McHale designed hydraulic brake. This variable stretch system ensures even net application during the entire bale binding process.

The brake places a resistance on the speed at which the roll of net can rotate, the greater the resistance the more stretch that is applied to the net. The operator can adjust net tension without having to leave the comfort and safety of the tractor cab.

Net Layer

The operator can select bale diameter and the number of layers of net to be applied from the control console. The machine will automatically adjust the net application for different bale diameters.



Net Loading & Storage

The operator simply releases the straps on the spare roll of net on the machine platform and moves the roll of net into position. To aid the loading process for the operator, the roll of net can be placed in the net roll loading cradle whilst being threaded through the netter. Once in position, the operator moves the net roll tension bar to hold the roll of net in place. Storage for two extra rolls of net is provided on the baler platform.

Bale Kicker Sensor

McHale V6 & V8 balers are fitted with a bale discharge sensor, which notifies the driver when the bale has left the bale chamber and has passed over the bale kicker. The heavy-duty bale kicker ensures a clean separation between the machine and the netted high-density bale.





McHale

22:20
OK
320 m
A
AUTO
000
284
10
125 cm
i

AUTO
MAN
MENU
Emergency Stop Button
Navigation Buttons
Function Buttons (Scissors, Saw, etc.)

EXPERT PLUS CONTROL CONSOLE

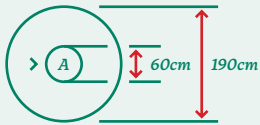
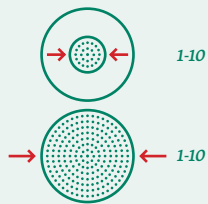
All McHale V6 & V8 machines are fitted with an Expert Plus control console, which has a **LARGE GRAPHIC DISPLAY**. From the control console in the tractor cab the operator can adjust the following;

<p>Core Size & Bale Size</p>	
<p>Core Density & Bale Density</p>	
<p>Revolutions of Net Being Applied</p>	
<p>The McHale Expert Plus Control Console also features:</p>	
<p>Knife Display</p>	<p>Door Position Display</p>
<p>Pre-Net Bale Formation Alert</p>	<p>Net Usage (Metres)</p>
<p>Bale Size Setting</p>	<p>Bale Size Display</p>
<p>Drop Floor Display</p>	<p>Lube Count</p>
<p>Lube Alarm</p>	<p>Net Layers</p>
<p>Bale Density</p>	<p>Bale Shape Indicator</p>

Easily Adjusted Bale Settings

The Expert Plus console, also gives the operator the choice of selecting a soft or hard bale core, depending on the customers feed out requirements. The control console can also store ten bale count totals so the operator can record ten different counts that may be associated with different fields or different customers.

Bale Size

The bale diameter can be adjusted on the control console from **0.6–1.68m (2'-5'6")** on the **V6 and Fusion Vario** machines and on the **V8** from **0.6–1.9m (2'-6'3")**. The preset diameter setting is displayed on the bottom information block on the main screen and a live diameter reading is displayed as the bale is being formed. There is also a vertical bar graph which shows progress as the bale is being made.

Bale Density

The core bale density, the outer bale density and the bale size can all be adjusted by the operator on the control console in the tractor cab.

Bale Profiles

A bale profile setting retains the operators personal setting choice from core diameter, bale diameter, core density, bale density, net layers and net stretch for use in different crops. There are 5 bale profile settings to choose from. Each profile will retain its own individual settings so that the machine can easily be changed to work in different crops without needing to change a lot of settings.

Bale Shape Indicators

The variable chamber baler range is fitted with bale shape indicators, which indicate to the driver via the control console, which side of the chamber needs to be filled. The bale shape indicators ensure that when the machine works in a light swath that the best bale shape is achieved.

The bale shape indicator arrows are also accompanied by a series of beeps so the operator does not need to watch the screen. A low tone is emitted when the operator needs to steer left and a higher tone for when the operator needs to steer right.

V6
740

V6740 NON-CHOPPER BALER



STANDARD SPECIFICATION

The McHale V6740 non chopper, variable chamber round baler features a star shaped, high-intake feed rotor to quickly and efficiently move the crop from the pick-up into the bale chamber. This maximises the baler performance and throughput.

V6 BALE SIZES

Unwrapped
All forage types

0.6m
(2')

1.68m
(5'6")

STANDARD FEATURES

THE V6740 NON-CHOPPER

The McHale V6740 is a high output non-chopper baler equipped as standard with drop floor unblocking, heavy duty belts, centralised greasing blocks and a continuous oiling system. The machine is fitted with 3-endless belts as standard and is capable of producing a bale from 0.6–1.68m (2'–5'6").



FEED ROTOR

The star shaped feed rotor fitted behind the pick-up on the V6740 variable chamber baler ensures a high capacity flow of grass into the bale chamber. As crop enters the rotor, twin finger rotating flights feed the crop through to the bale chamber. The flights on the rotor ensure high output, while the star layout reduces the load peaks as the V6740 works in heavy swaths.



ENDLESS ADJUSTMENT

Bale density and the number of layers of net being applied in the chamber can be easily adjusted as the machine passes through different crop conditions. On the Expert Plus control console, bale density and net adjustment can be controlled from the comfort of the tractor cab. The machine will automatically adjust the net application for different bale diameters.



Machine Features:

2.1m Pick-Up	Heavy Duty Feed Rotor	Drop Floor Unblocking System	3-Endless Belts
Centralised Greasing Blocks <i>(Manual Greasing)</i>	Continuous Oiler System	High Performance Stretch Net System	50mm (2") Double Race Chamber Bearings
1¼" Chain on the Bale Chamber	Expert Plus Control Console	Mechanical Tailgate Locking	Knife Pressure Display
Knife Position Sensor	Drop Floor Sensor	460/65/20 Tyres	Bale Kicker

OPTIONAL EXTRAS

For more information on optional extras see [page 35](#)

1. Camless Pick-Up

The 2.1m camless pick-up runs smoothly, particularly in short crop, and requires less maintenance due to a reduced number of rotating parts. All camless pick-ups are fitted with six tine bars and a double crop roller to provide excellent ground cleaning and fast delivery of crop to the rotor.

2. Crop Roller

A small diameter high throughput crop roller is also available for the V6740 variable chamber baler fitted with cam pick-ups. This crop roller helps to level out uneven swaths and has the ability to increase baler throughput.

Other Optional Extras

3. 1000rpm Gearbox
4. Single Full Width Endless Belt
5. Tyre Upgrades
6. Brakes
7. Moisture Meter Kit

V6
750

V6750 CHOPPER BALER



STANDARD SPECIFICATION

The McHale V6750 is a variable chamber round baler equipped with a 15-knife chopper unit and rotor. A double drive system aids belt rotation and bale formation to allow the machine to operate in the toughest of conditions. The machine comes with centralised grease blocks as standard. Automatic greasing is available as an optional extra.

V6 BALE SIZES

Unwrapped
All forage types

0.6m
(2')

1.68m
(5'6")

STANDARD FEATURES

15 KNIFE CHOPPER ROTOR

The McHale V6750 is equipped with a 15-knife chopper unit and rotor. As crop enters the spiral rotor, pairs of rotating flights feed the crop through the chopping unit.

The double flights on the rotor ensure high output, while the spiral layout reduces the load peaks as the machine works in heavy swaths. The rotor design encourages a uniform crop flow, which reduces the risk of blockages, thus maximising output.

With all 15 knives engaged, a theoretical chop length of 65mm is delivered. Knives can be engaged and disengaged from the cab.



KNIFE SENSOR

To ensure that the machine always delivers a good chop quality, two monitoring systems have been put in place on the V6750 baler.

Firstly, knife working pressure is monitored and displayed on the control console. If the knife pressure becomes too high or too low, audible and graphic alarms are activated to notify the operator.

Secondly, a sensor monitors the distance between the top of the knife and the spine on the rotor to ensure the knives are fully engaged. If the knife moves out of position for any reason the operator is notified via the control console.



Machine Features:

2.1m Pick-Up	15-Knife Chopper Unit with Heavy Duty Rotor	Drop Floor Unblocking System	3-Endless Belts
Centralised Greasing Blocks <i>(Manual Greasing)</i>	Continuous Oiler System	High Performance Stretch Net System	Mechanical Tailgate Locking
1¼" Chain on the Bale Chamber	Expert Plus Control Console	50mm (2") Double Race Chamber Bearings	Knife Pressure Display
Knife Position Sensor	Drop Floor Sensor	500/50/22.5 Tyres	Bale Kicker

OPTIONAL EXTRAS

For more information on optional extras see [page 35](#)

1. Selectable Knives

Selectable knives allow the operator to engage and chop with a bank of 7 knives, 8 knives or engage both knife banks, which will give a 15-knife chopper system capable of delivering a theoretical chop length of approximately 65mm.

2. Single Full Width Belt

A single full width, endless belt exerts a high pressure on the crop in order to form a dense bale in the chamber. This full width belt reduces crop loss, particularly in alfalfa and provides better belt traction for the operator compared to multiple endless belts.

Other Optional Extras

3. 1000rpm Gearbox
4. Camless Pick-Up with Double Crop Roller
5. Tyre Upgrades
6. Brakes
7. Moisture Meter Kit
8. ISOBUS Integration

V8
940

V8940 HIGH-CAPACITY NON-CHOPPER BALER



STANDARD SPECIFICATION

The McHale V8940 is high-capacity, non-chopper variable chamber baler is equipped with a high intake feed rotor to ensure even and efficient crop flow to the bale chamber. The V8940 is driven by a primary drive system for optimum bale formation using 3-endless belts.

V8 BALE SIZES

Unwrapped
All forage types

0.6m
(2')

1.9m
(6'3")

STANDARD FEATURES

ENDLESS BELT BALE CHAMBER

The bale chamber on the McHale V8940 variable chamber baler range is comprised of three heavy-duty endless belts as standard. The belts are extremely hard wearing and are reinforced with synthetic material, which ensures that the belts can absorb and apply high pressure to the material in the bale chamber.



DROP FLOOR UNBLOCKING

The McHale drop floor unblocking system is a feature which operators have come to love for its simplicity of use and effective unblocking cycle. As baling conditions are not always ideal, uneven swaths can occur which can lead to blockages. The drop floor unblocking system means blockages can be fed through in three simple steps.



MECHANICAL TAILGATE LOCKING

The tailgates on all McHale V8940 balers are fitted with a pair of mechanical locks, which keep the bale chamber securely closed. These locks remain activated until, the progressive density system reaches the pre-set bale size and density and the required amount of net has been applied. This eliminates the need for the chamber door to rely on hydraulic pressure when making high density bales.



Machine Features:

2.1m Pick-Up	Heavy Duty Feed Rotor	Drop Floor Unblocking System	3-Endless Belts
Centralised Greasing Blocks <i>(Manual Greasing)</i>	Continuous Oiler System	High Performance Stretch Net System	50mm (2") Double Race Chamber Bearings
1¼" Chain on the Bale Chamber	Expert Plus Control Console	Mechanical Tailgate Locking	Knife Pressure Display
Knife Position Sensor	Drop Floor Sensor	460/65/20 Tyres	Bale Kicker

OPTIONAL EXTRAS

For more information on optional extras see [page 35](#)

1. 1000rpm Gearbox

McHale variable chamber balers work in different conditions around the world so in order to optimise machine performance, a 1000rpm gearbox is available as an optional upgrade on all machines in the McHale variable chamber baler range.

2. Crop Roller

A small diameter high throughput crop roller is also available for the V8940 variable chamber baler fitted with cam pick-ups. This crop roller helps to level out uneven swaths and has the ability to increase baler throughput.

Other Optional Extras

3. Camless Pick-Up with Double Crop Roller
4. Tyre Upgrades
5. Brakes
6. Moisture Meter Kit

V8
950

V8950 HIGH-CAPACITY CHOPPER BALER



STANDARD SPECIFICATION

The McHale V8950 is a high capacity, semi-automatic variable chamber baler which is fitted with a 15-knife chopper unit and heavy-duty rotor. A double drive system aids belt rotation and bale formation to allow the machine to operate in the toughest of conditions.

V8 BALE SIZES

Unwrapped
All forage types

0.6m
(2')

1.9m
(6'3")

STANDARD FEATURES

DOUBLE DRIVE SYSTEM

In more difficult conditions, such as wet heavy grass, if the primary drive slips slightly, the double drive will engage in order to aid belt and material rotation in the chamber.

This double drive helps bale formation as a constant pressure is kept on the chamber belts which results in the production of a solid and uniform bale even when dealing with a wet and heavy crop. A cleaning auger is fitted to the double drive system in order to prevent crop build up and allow the double drive to aid bale rotation when working in wet or sugary crops.



BALE SHAPE INDICATORS

All machines in the McHale V8 variable chamber baler range are fitted with load sensing bale shape indicators that directly measure the bale pressure inside the chamber.

By comparing the loading on each side of the chamber, the bale shape is calculated and then indicated to the operator via the control console, which side of the chamber needs to be filled. This direct measuring of the chamber pressure allows the bale shape indicators to be extremely accurate and responsive.



Machine Features:

2.1m Pick-Up	15-Knife Chopper Unit with Heavy Duty Rotor	Drop Floor Unblocking System	3-Endless Belts
Centralised Greasing Blocks <i>(Manual Greasing)</i>	Continuous Oiler System	High Performance Stretch Net System	50mm (2") Double Race Chamber Bearings
1¼" Chain on the Bale Chamber	Expert Plus Control Console	Mechanical Tailgate Locking	Knife Pressure Display
Knife Position Sensor	Drop Floor Sensor	500/50/22.5 Tyres	Bale Kicker

OPTIONAL EXTRAS

For more information on optional extras see [page 35](#)

1. Automatic Greasing

All drive and non-drive side chamber bearings and rotor bearings are greased as the machine is working through the automatic greasing cycle. A measured amount of grease is distributed around the machine every time the bale chamber door opens.

2. Selectable Knives

Selectable knives allow the operator to engage and chop with a bank of 7 knives, 8 knives or engage both knife banks, which will give a 15-knife chopper system capable of delivering a theoretical chop length of approximately 65mm.

Other Optional Extras

3. 1000rpm Gearbox
4. Camless Pick-Up with Double Crop Roller
5. Tyre Upgrades
6. Brakes
7. Moisture Meter Kit
8. ISOBUS Integration

VARIABLE BALER RANGE OPTIONS

Options	Camless Pick-Up	Chopper Unit		Selectable Knives	
		15	25	0, 7, 8, 15	0, 12, 13, 25
V6740	Optional	N/A	N/A	N/A	N/A
V6750	Optional	Standard	Optional	Optional	Optional
V8940	Optional	N/A	N/A	N/A	N/A
V8950	Optional	Standard	Optional	Optional	Optional
Fusion Vario	Optional	Standard	Optional	N/A	Optional

McHale machines work in different conditions around the world. To optimise machine performance, **WE OFFER A NUMBER OF OPTIONS** in the Mchale variable chamber range.

We recommend you speak with your local dealer/distributor as regards the best configuration to meet your requirements.

Camless Pick-Up

The 2.1m camless pick-up runs smoothly, particularly in short crop, and requires less maintenance due to a reduced number of rotating parts. All camless pick-ups in the Mchale variable chamber baler range are fitted with six tine bars and a double crop roller to provide excellent ground cleaning and fast delivery of crop to the rotor.

Rotor / Chopper Unit

The 25 knife rotor and chopper unit is available as an option on the Mchale V6750, V8950 and Fusion Vario variable chamber machines and delivers a chop length of approximately 46mm.

Selectable Knives

A selectable knife system consists of two knife banks which allow for various knife configurations to be chosen depending on the knife bank specification. If a machine is equipped with 25 knives, then a bank of 12 and a bank of 13 knives are available to be chosen from. Where a machine is equipped with a 15 knife chopping unit, then a bank of 7 and a bank of 8 knives are available to be selected. If no chopping is required then the operator can select for no knives to be engaged. On all V6750 & V8950 machines, knife selection is engaged from the baler while on all Fusion Vario machines, knife selection can be decided from the tractor cab.

1000rpm Gearbox

McHale machines work in different conditions around the world so in order to optimise machine performance, a 1000rpm gearbox is available as an optional upgrade on all machines in the Mchale baler range.

Automatic Greasing

Automatic greasing is standard on all Mchale Fusion Vario machines but is available as an option on all Mchale V6750 & V8950 machines. Automatic greasing saves time as it reduces the amount of manual greasing to be done by the operator. All drive and non-drive side chamber bearings and rotor bearings are greased as the machine is working through the automatic greasing cycle. A measured amount of grease is distributed around the machine every time the bale chamber door opens on the Mchale Fusion Vario, V6750 and V8950 machines. The grease cartridge should be replaced after 1200 bales.

Brakes

All balers in the Mchale V6 and V8 variable chamber baler range can be equipped with brakes as an optional extra. Mchale offer the choice of hydraulic or air brakes. All Mchale Fusion Vario machines come fitted with hydraulic brakes as standard but can be specified with air brakes as an optional extra.

Single Belt

A single, full width, endless belt exerts a high pressure on the crop in order to form a dense bale in the chamber. Heavy-duty belts are manufactured to the highest of standards using layers of synthetic and rubber material to form a durable endless belt with no joins. This full width belt reduces crop loss, particularly in alfalfa or chopped material and provides better belt traction for the operator compared to multiple endless belts.

ISOBUS Integration

ISOBUS is available as an optional extra on all Mchale V6750 and V8950 machines. When the machine is fitted with ISOBUS, it can be plugged into any ISOBUS tractor connection and operated through the terminal in the cab.

Tyre Options

A number of tyre options are available to meet your requirements. Please see the table below for the tyre options available to suit your machine of choice.

Machine	Standard	Option 1	Option 2
V6740	460/65/20	500/50/22.5	560/45/22.5
V6750	500/50/22.5	560/45/22.5	—
V8940	460/65/20	500/50/22.5	560/45/22.5
V8950	500/50/22.5	560/45/22.5	—
Vario	650/50/22.5	680/50/22.5	—

1000rpm Gearbox	Single Belt	Greasing	ISOBUS Integration	Tyre Options	Brakes	
		Automatic Greasing			Hydraulic	Air
Optional	Optional	N/A	N/A	500 / 50 / 22.5 560 / 45 / 22.5	Optional	Optional
Optional	Optional	Optional	Optional	560 / 45 / 22.5	Optional	Optional
Optional	N/A	N/A	N/A	500 / 50 / 22.5 560 / 45 / 22.5	Optional	Optional
Optional	N/A	Optional	Optional	560 / 45 / 22.5	Optional	Optional
Optional	Standard	Standard	N/A	680 / 50 / 22.5	Standard	Optional



Fusion
VARIO



**ONE OPERATOR. ONE TRACTOR. TWO JOBS.
INCREASED PROFIT.**

STANDARD SPECIFICATION



The McHale Fusion Vario is a fully automatic variable chamber integrated baler wrapper, which consists of a high output baler and a vertical wrapping ring. The machine benefits from two unique patents; a patented bale transfer system and a patented vertical wrapping ring.

The McHale Fusion Vario is equipped with a host of **FEATURES AS STANDARD;**

2.1 Metre, Five Tine Bar Pick-Up	Crop Roller	iTouch Control Console	Inbuilt Camera System
Drop Floor Unblocking System	Double Drive Variable Bale Chamber	15 Knife Chopper Unit with Heavy-Duty Rotor	Single Belt Bale Chamber with Endless Belt
Bale Shape Indicators	Patented Bale Transfer Delivering Higher Output	High Speed Vertical Wrapping Ring	Fully Automatic Operation

ADVANTAGES OF THE FUSION VARIO

REDUCED LABOUR

As it is an integrated baler wrapper, only one operator and tractor is required to carry out the task of baling *and* wrapping which leads to reduced costs in labour.

ONE MACHINE

The Fusion Vario provides the operator with the flexibility to produce various size bales without the need to return to the yard to change machines for baling different types of crop over the course of a day.

REDUCED CROP LOSS

The single belt on the McHale Fusion Vario reduces crop loss compared to multiple belts which is particularly beneficial when baling short chopped crops such as alfalfa.

BALE ONLY PROGRAMME

When baling hay or straw, the operator has the ability to carry and place bales in pairs of two for easy collection.



Bale Size

The McHale Fusion Vario also has the ability to make bales of **hay and straw** from **0.6m to 1.68m (2'-5'6")** but in **haylage or silage**, it produces bales from **1m to 1.45m (3'3"-4'8")** to allow for wrapping.

Unwrapped

All forage types

0.6m
(2')

1.68m
(5'6")

Wrapped

Haylage/Silage

1m
(3'3")

1.45m
(4'8")

UNIQUE FEATURES DELIVERING HIGHER OUTPUT

The McHale Fusion Vario is a unique machine which benefits from two MCHALE PATENTS.

High Speed Transfer System

As the transfer cradle moves the bale towards the wrapping ring, the wrapping roller closest to the bale chamber pivots out of the way which reduces the height the bale has to travel to get to the wrapper. This clever system saves time, as the patented system moves the bale quickly ensuring the McHale Fusion Vario delivers the highest possible output.



WRAPPING SYSTEM

In normal working conditions the ever efficient wrapping process is ALWAYS COMPLETE AHEAD OF THE BALER, meaning that the wrapping platform is always ready and waiting to capture the next ejected bale.



01 *Two 750mm Dispensers*

The vertical wrapping ring on the Fusion Vario is fitted with two 750mm dispensers, which take under 20 seconds to apply 4 layers of film and approximately 25 seconds to apply 6 layers of film using both dispensers. This means the wrapping platform is always waiting for the next bale.



02 *Easy Film Loading*

Film can be loaded from the left hand side of the machine. After loading film on the first dispenser, the operator can push the index button and the dispensers will then rotate around and automatically stop at the loading position for the second dispenser. This allows the operator to easily load the second roll of film.



Tip Roller

The McHale Fusion Vario can produce bales of various sizes, from 1–1.45m (3'3"–4'8"), for wrapping with the high speed vertical wrapping ring. On adjustment of the bale size from the iTouch control console, the patented tip roller adjusts its height in line with the selected bale size to ensure the plastic always goes onto the centre of the bale, regardless of the bale diameter. This ensures the correct overlap is always achieved resulting in an even distribution of plastic on the bale.



03 Film Break Sensors

The dispensers are fitted with film break sensors, which notify the operator through the control console in the tractor cab if one or both dispensers run out of film. If one dispenser runs out of film the Fusion Vario will continue working and automatically slow bale rotation and increase the number of rotations of the wrapping ring to ensure that the bale is wrapped correctly.



04 Reliable Cut and Holds

On the last rotation of the wrapping cycle, the cut and holds extend out and the wrapping film is gently supported in the cut and hold rails, once supported the cut and hold gathers the wrapping film to one point where it is cut and held. By gathering the plastic to one point, this system makes the Fusion Vario's performance much more reliable, particularly in hot or wet conditions.

FEATURES OF THE iTOUCH CONTROL CONSOLE

The McHale “iTouch System” is a modern control console featuring the latest in touch screen technology. The iTouch boasts a large 7” colour screen in a rugged, hard-wearing enclosure displaying all the information that a user requires to monitor how the machine is performing.

The iTouch control console is fitted to the McHale Fusion Vario. This touch screen monitor features a 7” colour screen with easy to understand icons that control various functions on the machine. The McHale iTouch system was specifically designed and tested to be user friendly and this approach is reflected in its full colour screen and graphic display of all machine settings and functions.



Fully Automatic

The iTouch control console, when combined with the load sensing valve on the McHale Fusion Vario, is capable of making baling and wrapping fully automatic.

Bale Density & Net Adjustment

The iTouch control console allows for the bale density to be adjusted from the comfort of the tractor cab. From the iTouch control console, the operator can adjust the number of layers of net being applied to the bale. At the touch of a button, the operator can also adjust the stretch being applied to the net in the bale chamber from the iTouch control console in the tractor cab.

Auto Knife Drop

This feature allows for the operator to chop the forage until the bale is almost complete, at which point the machine will automatically lower the knives. Depending on the feeding method, this improves fodder distribution and machine intake.

Camera

The iTouch control console is fitted with a camera as standard on the McHale Fusion Vario. In manual mode, the operator can switch to camera mode to view the wrapper and rear of the machine.



In automatic mode, the camera image will appear at different predetermined times on the screen such as when the bale is being transferred or being tipped.

The operator can also select:

The knives in the chopper unit on or off

The machine to tip or hold the wrapped bale

A 'bale only' programme for hay or straw

A lube alarm

Various bale transfer options depending on ground conditions

Easy Pausing

Netting, bale transfer, wrapping and tipping stages of the automatic cycle can be easily and intuitively paused by the operator should the need arise.

Pre & Post Roll

The McHale Fusion Vario features a pre & post roll function which allows the bale to be rolled before and after the bale is wrapped. This ensures the net and plastic is bound tightly to the bale.

Additive Applicator

An output for controlling a crop additive applicator is featured on the iTouch control console. Once the operator has the PTO running this will engage an aftermarket crop additive applicator. During the application of the net and the transfer of the bale, the applicator will automatically switch off in order to avoid the wastage of additive. An optional headland management kit is also available to detect when the pickup is raised at headlands and switches off the applicator to avoid further wastage.

Undulating Ground

For operators working in difficult ground conditions, the bale tip speed can also be adjusted from the tractor cab.

Side Tip

External bale tip control buttons are fitted to allow for the side tip to be conveniently raised and lowered when changing from work to transport positions, or when attaching a side-tip to the machine. A safety sensor ensures the side tip is in the correct operating position before baling can begin.

Customer Data System

The McHale iTouch control console is primarily for monitoring and configuring machine performance but also contains additional features that the professional farmer and contractor will find invaluable in their day to day activities.

All McHale iTouch control consoles possess a built-in database for storing customer profiles and work performed with the machine which can be displayed on the iTouch 7" screen. Information such as customer name, number of bales wrapped/

un-wrapped & number of bales chopped/un-chopped can be easily viewed providing full visibility of all jobs completed. Up to 10 job totals can be stored on the iTouch.



Bale Weighing System

If fitted with the optional bale weighing system, the iTouch displays a bale weight icon on its main screen providing the calculated bale weight. The bale weights are accumulated and an average bale weight for the current customer is shown in the individual customer's profile.

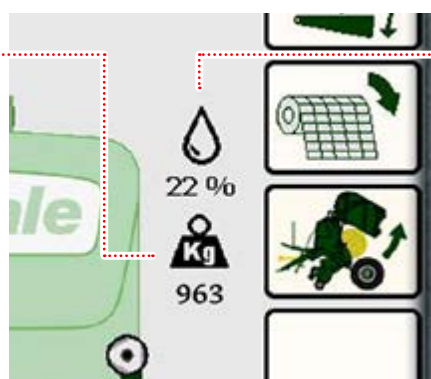

Bale Moisture Recording

When fitted with the optional bale moisture recording system, a moisture icon will be shown on the main screen. When the bale is almost full, the moisture values are recorded up until netting begins. Once netting begins, an average moisture value is calculated and displayed. This value is accumulated to create an average moisture content for the job.



VARIABLE BALER RANGE TECHNICAL TABLE

	V6 740	V8 940	V6 750	V8 950	FUSION VARIO
BALE CHAMBER					
Diameter	0.6–1.68m (2'-5'6")	0.6m–1.9m (2'-6'3")	0.6–1.68m (2'-5'6")	0.6–1.9m (2'-6'3")	0.6–1.68m (2'-5'6")
Width	1.23m (4')		1.23m (4')		1.23m (4')
Bale Chamber Feed	High Intake Feed Rotor		15 Knife Chopper Feed Rotor		15 Knife Chopper Feed Rotor
Number of Belts	3		3		1
CHOPPER UNIT					
Number of Knives	0		15		15
Theoretical Chop Length	N/A		65mm		65mm
Knife Protection	N/A		Hydraulic		Hydraulic
Knife Deactivation	N/A		Hydraulic from Cab		Hydraulic from Cab
Unblocking System	Drop Floor		Drop Floor		Drop Floor
PICK-UP					
Working Width	2100mm (6'11")		2100mm (6'11")		2100mm (6'11")
Tine Bars	5 (6 on Camless Pick-up)		5 (6 on Camless Pick-up)		5 (6 on Camless Pick-up)
Tine Spacing	70mm		70mm		70mm
Short Crop Guard	Standard		Option		Option
Crop Roller	Option		Standard		Standard
Pick-Up Guide Wheels (pneumatic)	Standard		Standard		Standard
NET WRAP					
Control	Automatic or Manual		Automatic or Manual		Automatic or Manual
Net System	High Performance Netter		High Performance Netter		High Performance Netter
Net Roll Capacity	1 + 2 Storage		1 + 2 Storage		1 + 2 Storage
Net Adjustment	In Cab		In Cab		In Cab
TRANSMISSION					
Gearbox	Split Drive		Split Drive		Split Drive
Main Drive Protection	Cam Clutch		Cam Clutch		Cam Clutch
Pick-Up Protection	Slip Clutch		Slip Clutch		Slip Clutch
Chain Lubrication	Continuous		Continuous		Continuous
Bale Chamber	Primary Drive		Double Drive		Double Drive
CONTROL					
Control System	Expert Plus		Expert Plus		iTouch
Operation	Semi-Automatic		Semi-Automatic		Fully Automatic
Density Adjustment	In Cab		In Cab		In Cab
Bale Size Adjustment	In Cab		In Cab		In Cab
Inbuilt Camera	N/A		N/A		1x In-built Camera
OTHER					
Axle	8 Stud		8 Stud		8 Stud
Brakes	Option: Air / Hydraulic		Option: Air / Hydraulic		Standard: Hydraulic (Option: Air)
Tyres Standard	460/65/20		500/50/22.5		650/50/22.5
Tyres Optional	500/50/22.5 or 560/45/22.5		560/45/22.5		680/50/22.5
Bale Kicker	Standard		Standard		N/A
Side Tip	N/A		N/A		Option
Road Lights	Standard		Standard		Standard
DIMENSIONS & WEIGHT					
Length	4.8m* (15'9")	5.1m* (16'9")	4.8m* (15'9")	5.1m* (16'9")	6.3m (20'8")
Width	2.54 / 2.58* (8'4" / 8'6")	2.58 / 2.62* (8'6" / 8'7")	2.54 / 2.58* (8'4" / 8'6")	2.58 / 2.62* (8'6" / 8'7")	2.94m (9'8")
Height	2.75m (9')	3.12m (10'3")	2.75m (9')	3.12m (10'3")	3.3m (10'10")
Weight	4430kg* (9,766 lbs)	4,740kg* (10,450 lbs)	4,540kg* (10,009 lbs)	4,850kg* (10,692 lbs)	6500kg* (14,330 lbs)
TRACTOR					
Minimum Hydraulic Flow	30 Litres / min at 180 bar		30 Litres / min at 180 bar		45 Litres/ min at 180 bar
Hydraulic System	2 double acting spools, 1 free flow return		2 double acting spools, 1 free flow return		Open Centre, Closed Centre or Load Sensing
Electronics	12 Volt DC, 20 amp		12 Volt DC, 20 amp		12 Volt DC, 20 amp
Minimum PTO Requirements	55 kW (73hp)		60 kW (80hp)		85kW (114hp)

* Value will vary depending on specification

A Unique to the **V8 machines**

A Higher specification
over the **V6740 & V8940**

A Unique to the **Fusion Vario**



05 - 21 - 003

M-Hale

Ballinrobe,
Co. Mayo,
Ireland

T. 353 (0) 94 95 20300
F. 353 (0) 94 95 20356
E. sales@mchale.net

WWW.MCHALE.NET

Distributed by:

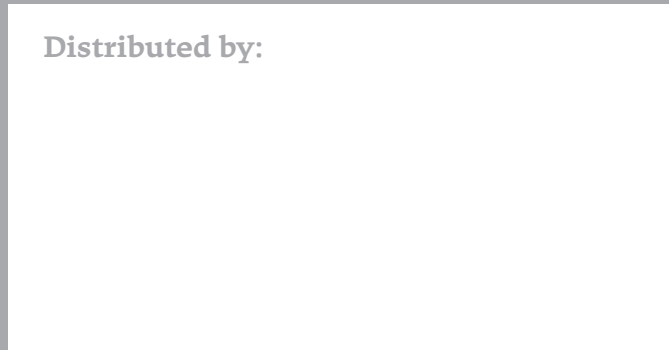

DISCLAIMER: This literature is designed for worldwide circulation. Due to a continuing policy of product improvement, we reserve the right to alter specifications and constructions without notice. As machines are exported to many different countries, general information, pictures and descriptions are provided; these should be taken as approximate and may include optional equipment that is not part of the standard specification. Please consult your local dealer or distributor for further information.